

# Code Encryptor II

Patent Pending - Part #CE2Y-LX

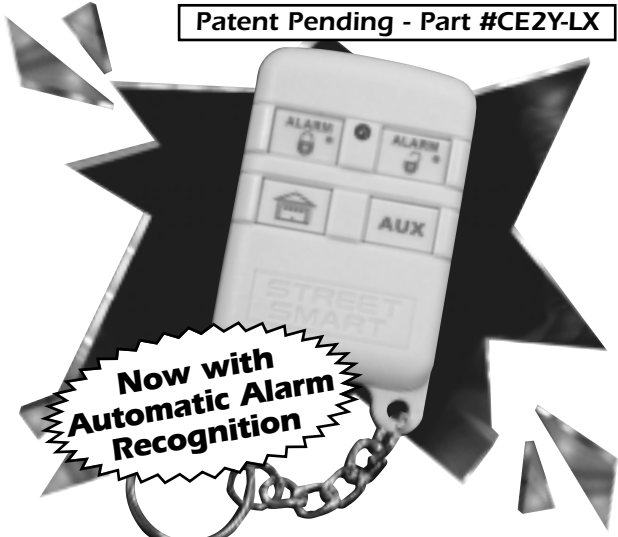

Now with Automatic Alarm Recognition

## Installation Manual Street Smart Security

### Installation

Red Aux +  
Black Aux -  
Yellow Keypad Data Line  
Green Keypad Data Line

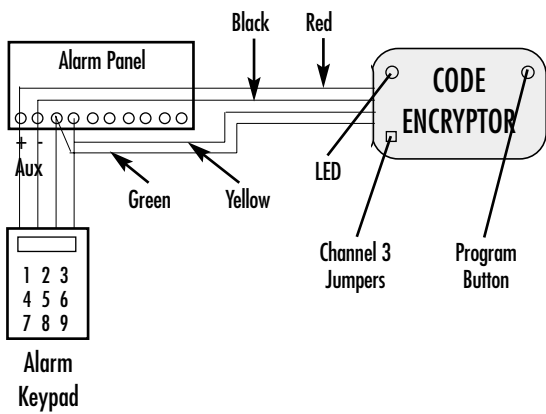

### Code Encryptor II

Location of the control module is the most important determining factor for range and reliability of your Code Encryptor. Select a location that is as centrally located as possible. Keep in mind that your customer will want to control the operation of the garage door from the driveway, and will also expect the use of the remote for alarm On/Off in the area of entry and exit.

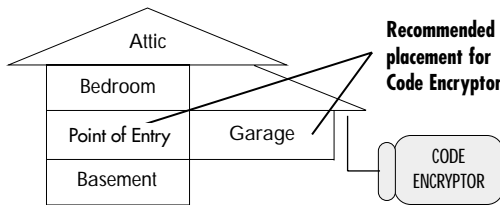

Since the Code Encryptor uses the communication bus wires from the keypad, you may want to place the receiver in or near the garage to easily control the following

- Easy connection to the garage door push button
- Easy visual LED status mounting location
- Easy connection to the keypad wires for complete alarm control

Although you can wire at the panel, it may reduce labor by installing the Code Encryptor II receiver at the point of entry. In most cases that is the garage which will provide an easy installation for garage door Open/Close, status indicator and alarm controls through the keypad. **DO NOT MOUNT THE CONTROL MODULE IN THE ALARM PANELS METAL ENCLOSURE.**

### Wiring Diagram

Yellow	Connect to yellow of keypad *Moose panels connect to white of keypad
Green	Connect to green of keypad
Gray	(-) Channel 2 Timed Output
Red/White	Channel 2 N/O relay (Garage Door Pushbutton)
White	Channel 2 Common (Garage Door Pushbutton)
Brown	Channel 3 Common (5amp)
Brown/White	Channel 3 N/O (5amp)
Blue/Green	Channel 3 N/C (5amp)
Red	+12VDC
Black	(-) Ground
Purple	LED (-) Output

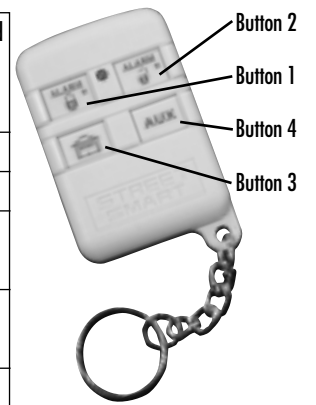

Button 1 Alarm ON/STAY  
Button 2 Alarm OFF  
Button 3 Garage Door OPEN/CLOSE  
PANIC OUTPUT Hold Buttons 1 and 2 for 3 seconds  
Button 4 RELAY OUTPUT

3

### Mandatory Programming

Programming a User Code is mandatory when using the Code Encryptor II. This gives the Code Encryptor microprocessor a User Code to arm and disarm the panel.

- Step 6)** Verify that the four-digit code you plan to teach the Code Encryptor II is a valid four-digit user code. Example: From the keypad use that four-digit code to arm the panel. If the panel arms, that is a good code. If it does not, program that user code into the alarm panel. — The Code Encryptor II uses that four-digit code to arm and disarm the panel, thus that code must be valid.\*
- Step 7)** Press and **HOLD** the program button on the receiver. The light will come **ON** and stay **ON** for three seconds then turn **OFF**. Once the light turns off, **RELEASE** the program button, the light will begin to flash rapidly.
- Step 8)** Using the keypad, slowly and firmly enter the four-digit user code. After the fourth entry the LED will stop flashing. This code has now been entered into the Code Encryptor's non-volatile memory. The Code Encryptor will remember this user code in the event of a power failure. To change to a new user code, repeat steps 7 and 8 above.

\*NOTE: We recommend using a user code that the customer cannot change. If the user code that is programmed into the CE Module is changed, the Code Encryptor II will not disarm the alarm panel.

### Wiring and Auto Recognition

#### COMPLETE STEPS 1-8

- Step 1)** Unplug the receiver from the wire harness.  
**Step 2)** Wire the Red, Black, Yellow and Green to the keypad.

RED Connect to Keypad Red or Aux (+)  
BLACK Connect to Keypad Black or Aux (-)  
GREEN Connect to Keypad Green  
YELLOW Connect to Keypad Yellow  
\*Moose ZX200/400/900/950 Connect to the White wire.

**NOTE:** You can make these connections at the panel or at the keypad itself. If you place the Code Encryptor II in the garage or any other location away from the panel you may choose to wire the Code Encryptor II directly to the keypad.

- Step 3)** Make sure the alarm panel is powered up and operating.  
**Step 4)** While watching the LED light on the Control module, plug the receiver into the Code Encryptor II harness.  
**Step 5)** The LED will blink 1 time on power up, after 2 seconds COUNT the flashes that you see. The corresponding flashes will indicate which panel the Code Encryptor II has detected.

4

### Mandatory Programming Continued

Press and Release button #1 Alarm "Away"  
Press and Release button #2 Alarm "Disarm"  
Press and Hold buttons 1 for 3 seconds Alarm "Stay" or "Bypass"  
Press and Hold buttons 1 and 2 for 3 seconds "Panic"

**NOTE:** The Code Encryptor II will arm in the AWAY mode even if you are outside the house. You do not have to arm the alarm before you exit. We do however recommend that you Arm the alarm system with in sight of the status LED or keypad to verify that the alarm has received and responded to your remote request.

SEE PAGE 16 FOR DSC 1550 AND CADDX 8980E.

The Code Encryptor II on the following panels self enroll themselves as a specific keypad address code.

- Ademco addressable Address #3
- Moose ZX200/ZX400 addressable Address #4

**DO NOT USE ANY OF THESE ADDRESS CODES IF YOU ARE USING ONE OF THE ABOVE PANELS.** EXAMPLE: If you are using an Ademco Addressable, no keypads can use address #3 since the CE II will automatically enroll itself as address #3.

### Automatic Recognition Continued:

Number of Flashes	Alarm Panel detected by the CE II
1	No Alarm connected (CE II defaults to relay mode) SEE PAGE 15 "Default Mode"
2	Napco 1000E Series (including 1008E, 1016E, etc.)
3	Moose Z880/Z900/Z950
4	Caddx 8600E, 8980E
5	Ademco Non Addressable
6	Ademco Addressable
7	DSC 1555/1565/5010 (Power 832)/5015/580
8	DSC 1550, 2525, 2550, 3000
9	Moose ZX200/ZX300/ZX400
10	Moose Z1100E, ADT A910
11	
12	Moose Z1100

Go to Mandatory Programming (Steps 6, 7 and 8)

**NOTE: If the CEII does not detect correctly, call Technical Toll Free 888-768-2846 7am-5pm PST**

6

### Channel 2 Outputs

(Every time button #3 is pressed, two outputs happen simultaneously.)

Output #1	Momentary Contact Closure for Opening and Closing garage door (See Garage Door Interface)
Output #2	500ma (-) output for 3 minutes, (See Channel 2 Timed Output)

### Garage Door Interface

All garage doors have a wall mounted push button that activates the door via a two-wire connection. Make your connection at the push button switch or at the garage door motor where these two wires terminate. The Code Encryptor II will interface with this connection by attaching the red/white and white wires from the Code Encryptor II to these two wires. If you choose to connect to the motor, trace the wires from the push button to the motor to determine the proper connection point. Most garage doors (except MOM Crusader models) use terminals #1 and #2. For MOM Crusader models, use terminals #2 and #3.

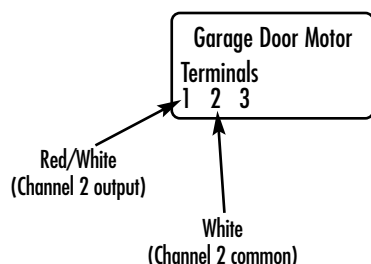

9

### Channel 2 Timed Output

Every time you press button 3 on the Code Encryptor II remote the Gray wire sends a 500ma (-) output for 3 minutes.

**Application #1** - If you hardwire the garage door you can use this output to trigger a 12VDC relay that will energize when you open or close your garage door extending your entry/exit delay by another 3 minutes. For security, you can make the entry delay minimal so if a thief enters through the garage, the entry delay will be short. If the homeowner opens the garage with our Code Encryptor II we will extend the entry delay by 3 minutes. If you are using the status output in the garage then you may not need this extra time, as our remote can immediately de-activate the alarm system and you will receive visual indication the alarm is disarmed. **NOTE: If you are using this output see additional programmability on page 20.**

**Application #2** - You can use this output to drive entry/exit illumination. Every time the customer enters or exits the house this output can trigger a relay or an X-10 powerflash module to interface with driveway, porch or Malibu lighting, illuminating their way as they leave and return home. The output activates automatically when you press button 3 on the Code Encryptor II remote and will shut off after 3 minutes. **NOTE: If you are using this output see additional programmability on page 20.**

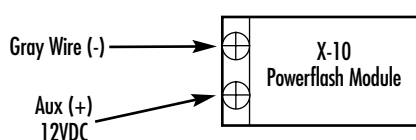

10

### LED Wiring

DO NOT CONNECT LED DIRECTLY TO GROUND!

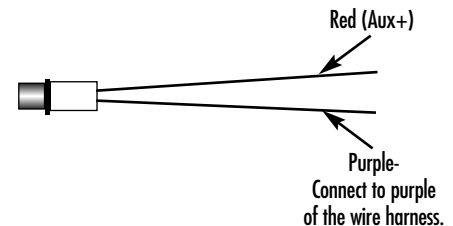

The LED is a low voltage type and must run through the Code Encryptor II. If you attempt to connect the purple wire directly to ground (-) the LED will burn and will NOT operate again.

Go TO Channel 2 Outputs

8

### Channel 3 Applications

Press and Release button #4 See Relay Output

#### Relay Output

(Not applicable for DSC 1550 or Caddx 8980E, see page 16.)

Occasionally, you may want to use Channel 3 for control of optional accessories (i.e., Malibu lighting, sprinklers, X-10 automation). The Code Encryptor II provides the ability to reconfigure Channel 3 to a variety of popular outputs using the on-board jumpers. The output provided from the Code Encryptor II is a 5amp from C relay (Common, N/O, N/C).

Jumper Configuration	Channel 3 Output Type
Both jumpers in (default)	Momentary output
Jumper closest to the harness removed	Latching (on/off) output
Jumper farthest from the harness removed	75sec timed output
Both jumpers out	150sec timed output

This output is a 5amp Form C relay (Common, N/O, N/C). To energize relay, press and release button number 4. You must RELEASE the button before the relay will energize.

11

## Panic Mode

Press and hold buttons 1 and 2 on the remote control for at least 3 seconds. This will cause the panel to go into a panic mode. Press button 2 to disarm the panel. **FOR DSC 1555/832 AND MOOSE ZX200/ZX400 YOU MUST ENTER YOUR FOUR-DIGIT USER CODE TO CANCEL THE REMOTE PANIC. THE REMOTE WILL NOT CANCEL A PANIC.**

### DEACTIVATING THE PANIC FEATURE:

In the event the user does not want to access a panic button through the remote control, it can be de-activated from the Code Encryptor II's memory.

- Step 1) Unplug the wire harness from the Code Encryptor II.
- Step 2) Press and HOLD the program button.
- Step 3) While HOLDING the program button, plug the Code Encryptor II harness back in. The LED light located on the front will turn ON.
- Step 4) Wait until the light turns "OFF".
- Step 5) Once the light has turned "OFF" release the button

12

### DEFAULT MODE:

- If the Code Encryptor II fails to recognize any of the data coming from the keypad wires, it will automatically default to a relay mode for button #1
- If this happens, verify that you are properly wired to one of the alarms listed on page 5.
- If you have connected the CE II to an alarm it does not recognize, follow the wiring below for a keyswitch mode.
- Program a selected zone as "Keyswitch Arming."
- Do not use the green or yellow wires.

### Installation for Keyswitch Arming

Red	Aux +
Black	Aux -
Brown/White	Zone programmed for keyswitch arming
Brown	Common adjacent to zone

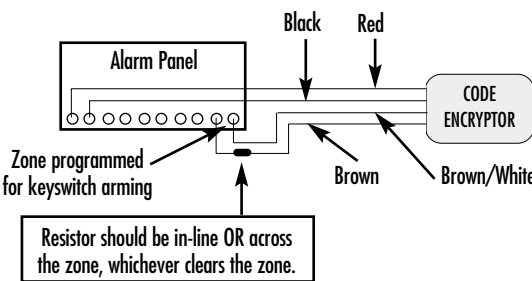

15

## Troubleshooting

**PROBLEM:** I press Button #1 but nothing happens.

**SOLUTION:** 1) Did you teach the Code Encryptor II a VALID four-digit user code?  
*Note: The code you teach the Code Encryptor II must be a master code or one of the current user codes.*

2) Press button #3, if you do NOT hear a "click" at the receiver, GO TO PAGE 14 and learn that remote into the Code Encryptor II.

**PROBLEM:** I press and hold button #1 and 2 and I do not get a panic.

**SOLUTION:** 1) Did you program the panel for keypad panic?  
 2) To program the Code Encryptor II for panic GO TO PAGE 13.

**PROBLEM:** I am using a DSC 1555 or a Power 832 and the alarm will not ARM with the remote.

**SOLUTION:** Make sure you program the Alarm panel for "Quick Key Enable" Section 015 #4 light "ON". Power down the alarm panel and power it back up. Wait at least 60 seconds before you attempt to use the remote control.

**PROBLEM:** I am using a DSC 1555 or a Power 832 and the alarm will not DISARM with the remote.

**SOLUTION:** Enter panel programming. Go to section 017. Make sure light #1 is on.

**PROBLEM:** I am using a Moose Z900/Z950/Z1100/Z1100E/ADT A910 and it is mis-identifying.

**SOLUTION:** Close zone one while plugging the CE II in.

**PROBLEM:** Unit does not seem to identify the panel I am using.

**SOLUTION:** Call technical 888-768-2846.

18

## Street Smart Limited Warranty

Street Smart, a Division of Pitway Corporation, and its divisions, subsidiaries and affiliates ("Seller"), 12925 Brook Printer Place, Suite 410, Poway, California 92064, warrants its products to be in conformance with its own plans and specifications and to be free from defects in materials and workmanship under normal use and service for 24 months from the date stamp control on the product or, for products not having a Street Smart date stamp, for 12 months from date of original purchase unless the installation instructions or catalog sets forth a shorter period, in which case the shorter period shall apply. Seller's obligation shall be limited to repairing or replacing, at its option, free of charge for materials or labor, any product which is proved not in compliance with Seller's specifications or proves defective in materials or workmanship under normal use and service. Seller shall have no obligation under this Limited Warranty or otherwise if the product is altered or improperly repaired or serviced by anyone other than Street Smart factory service. For warranty service, return product transportation prepaid, to Street Smart Factory Service, 12925 Brook Printer Place, Ste. 410, Poway, California 92064.

THERE ARE NO WARRANTIES, EXPRESS OR IMPLIED, OF MERCHANTABILITY, OR FITNESS FOR A PARTICULAR PURPOSE OR OTHERWISE, WHICH EXTEND BEYOND THE DESCRIPTION ON THE FACE HEREOF. IN NO CASE SHALL SELLER BE LIABLE TO ANYONE FOR ANY CONSEQUENTIAL OR INCIDENTAL DAMAGES FOR BREACH OF THIS OR ANY OTHER WARRANTY, EXPRESS OR IMPLIED, OR UPON ANY OTHER BASIS OR LIABILITY WHATSOEVER, EVEN IF THE LOSS OR DAMAGE IS CAUSED BY THE SELLER'S OWN NEGLIGENCE OR FAULT.

Seller does not represent that the products it sells may not be compromised or circumvented; that the products will prevent any personal injury or property loss by burglary, robbery, fire or otherwise; or that the products will in all cases provide adequate warning or protection. Customer understands that a properly installed and maintained alarm may only reduce the risk of a burglary, robbery, fire or other events occurring without providing an alarm, but it is not insurance or a guarantee that such will not occur or that there will be no personal injury or property loss as a result. CONSEQUENTLY, SELLER SHALL HAVE NO LIABILITY FOR ANY PERSONAL INJURY, PROPERTY DAMAGE OR OTHER LOSS BASED ON A CLAIM THE PRODUCT FAILED TO GIVE WARNING. HOWEVER, IF SELLER IS HELD LIABLE, WHERE DIRECTLY OR INDIRECTLY, FOR ANY LOSS OR DAMAGE ARISING UNDER THIS LIMITED WARRANTY OR OTHERWISE, REGARDLESS OF CAUSE OR ORIGIN, SELLER'S MAXIMUM LIABILITY SHALL NOT IN ANY CASE EXCEED THE PURCHASE PRICE OF THE PRODUCT, WHICH SHALL BE THE COMPLETE AND EXCLUSIVE REMEDY AGAINST SELLER. This warranty replaces any previous warranties and is the only warranty made by Seller or this product. No increase or alteration, written or verbal, of the obligations of this Limited Warranty is authorized.

21

## Panic Continued

### ACTIVATING THE PANIC MODE

**NOTE: This is the default setting of the Code Encryptor II.**

If you have previously programmed remote panic "OFF" and would like to turn it back "ON" follow the steps below. If this is a NEW installation Panic "ON" is the DEFAULT setting for the Code Encryptor II.

- Step 1) Unplug the wire harness from the Code Encryptor II.
  - Step 2) Press and HOLD the program button.
  - Step 3) While HOLDING the program button, plug the Code Encryptor II harness back in. The LED light located on the front will turn ON.
  - Step 4) Immediately release the program button.
- IF NECESSARY, PROGRAM THE ALARM PANEL FOR KEYPAD PANIC.**

13

## DSC 1550 and Caddx 8980E

- DSC 1550 or Caddx 8980E panels work differently than other panels. When either of the two alarm systems are armed they automatically arm in the STAY or BYPASS mode until an entry/exit zone is tripped.
- Because of this panel set up, the Code Encryptor II has provisions to overcome this problem.

If you are using one of these two panels follow the instructions below.

- Step 1) Verify that the Code Encryptor II recognizes the alarm system as a Caddx 8980E or a DSC 1550 (see page 5)
- Step 2) Use the Channel 3 relay wires to bypass the zone.
- Step 3) Remove both jumpers located next to the wire harness

Every time the Code Encryptor II is armed in the Away mode, the relay will energize for 1 full second to open or close the Entry/Exit zone. If the customer is already outside the house when the panel is armed, the relay will trigger that zone automatically to move the panel from BYPASS to Away mode.

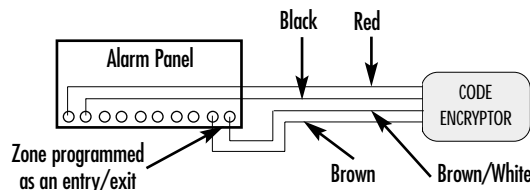

Channel 3 wires offer N/O and N/C contacts.  
 Utilize the wires to open or close the zone based on your installation.

16

## Specifications

### RECEIVER

- 12VDC Power Input
  - Channels 1 Data outputs
  - Channel 2 Relay N/O, Comm (10amp)
  - Channel 3 selectable: Form C Relay (N/O, N/C, Comm) 5amp  
 This output can be reconfigured from a pulsed output to a latching, 75 second timed or 150 second timed output.
  - Channel 3 - Keypad panic data output (Programmable On or OFF)
- Frequency** 303Mhz  
**Stand by Power Consumption** 15ma  
**Temperature Range** -5°F to 160°F (Indoor use only)

### REMOTE CONTROL

**Battery** 12VDC Mini (Part #GP23A) Replace battery once a year.  
**Range** 150+ feet

### CHANNEL 3 OUTPUT

Both jumpers in (default)	Momentary output
Jumper closest to the harness removed	Latching (on/off) output
Jumper farthest from the harness removed	75sec timed output
Both jumpers out	150sec timed output

### STREET SMART SECURITY TECHNICAL CAN BE REACHED

12925 Brookprinter Place, Suite 410, Poway, CA 92064  
 M-F 7AM-5PM PST AT (888) 768-2846 OR (619) 513-9352-FAX

19

## Federal Communications Commission (FCC) Statement

This equipment has been tested to FCC requirements and has been found acceptable for use. The FCC requires the following statement for your information:

This equipment generates and uses radio frequency energy and if not installed and used properly, that is, in strict accordance with the manufacturer's instructions, may cause interference to radio and television reception. It has been type tested and found to comply with the limits for a Class B computing device in accordance with the specifications in Part 15 of FCC Rules, which are designed to provide reasonable protection against such interference in a residential installation. However, there is no guarantee that interference will not occur in a particular installation. If this equipment does cause interference to radio or television reception, which can be determined by turning the equipment off and on, the user is encouraged to try to correct the interference by one or more of the following measures:

- If using an indoor antenna, have a quality outdoor antenna installed.
- Reorient the receiving antenna until interference is reduced or eliminated.
- Move the receiver away from the control/communicator.
- Move the antenna leads away from any wire runs to the control/communicator.
- Plug the control/communicator into a different outlet so that it and the receiver are on different branch circuits.

If necessary, the user should consult the dealer or an experienced radio/television technician for additional suggestions.

The user or installer may find the following booklets prepared by the Federal Communications Commission helpful: "Interference Handbook" This booklet is available from the U.S. Government Printing Office, Washington, DC 20402. The user shall not make any changes or modifications to the equipment unless authorized by the installation instructions or User's Manual. Unauthorized changes or modifications could void the user's authority to operate the equipment.

22

## To Add or Delete Remotes

### TO ADD A NEW REMOTE

#### METHOD #1

To add a remote to your Code Encryptor II, disarm the panel and Enter 78738 from the keypad. The system will arm in the "STAY" mode. Press button #1 until the arm system disarms. It should take a total of four presses. THIS FEATURE IS NOT AVAILABLE ON THE MOOSE ZX200/ZX400.

#### METHOD #2

To add a remote to your Code Encryptor II PRESS AND RELEASE the program button on the receiver. The light on the receiver will come ON. Immediately PRESS button 1 on the new remote control THREE TIMES. The light on the receiver should go OFF, indicating the remote has been learned. If the light on the receiver stays ON, the remote has not been learned. Remove and replace the harness, wait 15 seconds while auto recognition occurs and follow these instructions again.

The Code Encryptor II can hold up to seven remotes.

14

### TO DELETE ALL REMOTES

#### METHOD #1

To delete a lost or stolen remote from the Code Encryptor II, you must purge the entire memory. This will delete all of the current remotes. You will then have to add them back in one at a time. To purge the memory, disarm the panel. Enter 76278 from the keypad. The keypad on most panels will "beep" or the lights will turn off momentarily to confirm delete. Follow the instructions on page 14 (To Add a New Remote).

#### METHOD #2

To delete a lost or stolen remote from the Code Encryptor II, you must purge the entire memory. This will delete all of the current remotes. You will then have to add them back into memory. To purge, PRESS AND HOLD the program button, the light will come ON for four seconds, then go OFF, and finally it will come ON again, indicating that all the remotes in memory have been purged. Release the program button and follow the instructions on page 14 (To Add a New Remote).

17

## Canadian Department of Communications (DOC) Statement

**NOTICE:** The Canadian Department of Communications label identifies certified equipment. This certification means that the equipment meets certain telecommunications network protective, operational and safety requirements. The Department does not guarantee the equipment will operate to the user's satisfaction. Before installing this equipment, users should ensure that it is permissible to be connected to the facilities of the local telecommunications company. The equipment must also be installed using an acceptable method of connection. In some cases, the company's inside wiring associated with a single line individual service may be extended by means of certified connector assembly (telephone extension cord). The customer should be aware that compliance with the above conditions may not prevent degradation of service in some situations.

Repairs to certified equipment should be made by an authorized Canadian maintenance facility designed by the supplier. Any repairs or alterations made by the user to this equipment, or equipment malfunctions, may give the telecommunications company cause to request the user to disconnect the equipment.

Users should ensure for their own protection that the electrical ground connections of the power utility, telephone lines and internal metallic water pipe system, if present, are connected together. This precaution may be particularly important to rural areas.

**CAUTION:** User should not attempt to make such connections themselves, but should contact the appropriate electric inspection authority, or electrician, as appropriate.

The Load Number (LN) assigned to each terminal device denotes the percentage of the total load to be connected to a telephone loop which is used by the device, to prevent overloading. The termination on a loop may consist of any combination of devices subject only to the requirement that the total of the Load Numbers of all the devices does not exceed 100.

23